

X-Series (Brushless Gear Pumps)

MODEL 2212-X05/X06/X07

2212-X05/X06/X07

Made in the USA

DESCRIPTION

Flight Works X-Series (Brushless) Gear Pumps are designed to meet the performance and reliability requirements of a wide variety of industries and applications. The 2212-X05/X06/X07 models use precision-machined parts and a high-torque, high-speed brushless motor to create an extremely power dense product with enhanced operating life. The Swiss-made brushless motor reduces EMI and allows for precise feedback and control options, while the advanced pump head design offers higher durability and reliability, compared to the R- or C-Series options.



STANDARD SPECIFICATIONS

Diff. Pressure (Max)	Up to 200 psi
Flow Rate	Up to 210 mL/min
Weight	95 grams
Fluid Temp.	0° C to 100° C
Std. Port Size	M3 x 0.5 Threads
Std. Voltages	6V (X05), 12V (X06), 24V (X07)
Permissible Fluids (P/N Specific)	Light & Heavy Fuels/Oils (e.g. Kerosene), Water, Alcohols, Solutions, etc.
Control Options	Open-Loop Control (Voltage) Closed-Loop Control (RPM/Current)

APPLICATIONS

All Flight Works micro gear pumps feature a level of versatility and customization that allows for use in a wide field of applications, including:

- UAVs
- Fuel Cells
- Instrumentation
- Laboratory Experiments
- Medical
- Aerospace

▲ IMPORTANT

This pump is designed to run with an inlet filter (25 microns or better), and should NOT be run dry for extended periods of time.

NOTE: This pump is a precision unit, built and assembled as a complete product. Opening or dropping the pump can permanently damage assembly integrity. Specifications are for informational purposes only and may vary depending on the system in which the pump is integrated. Flight Works, Inc. makes no warranties concerning the suitability of this pump for a particular application; as such, it is the customer's responsibility to determine the safety and technical suitability of the system. Specifications subject to change without notice.

CONSTRUCTION OPTIONS

PART	LIGHT OIL CONFIGURATION	WATER CONFIGURATION	OPTIONS
PUMP HEAD	Anodized Aluminum	Anodized Aluminum	Stainless Steel
GEARS	416 SS & Hardened 420 SS	17-4 SS	PEEK Plastic PTFE-Filled Delrin Glass-Filled PTFE Bronze
IDLE PIN	Alloy Steel	Ceramic	Heat-Treated SS
SEALS	Viton	Viton	Buna Nitrile EPDM
FITTINGS	Barbed	Barbed	Push-to-Connect Compression
MOTOR	Standard	Standard	Custom Bearings Custom Lubrication Terminated Wiring

*Custom configurations can be designed upon customer request
(Ex. custom cover designs, welding, custom wiring, etc.)*

DIMENSIONS (mm)

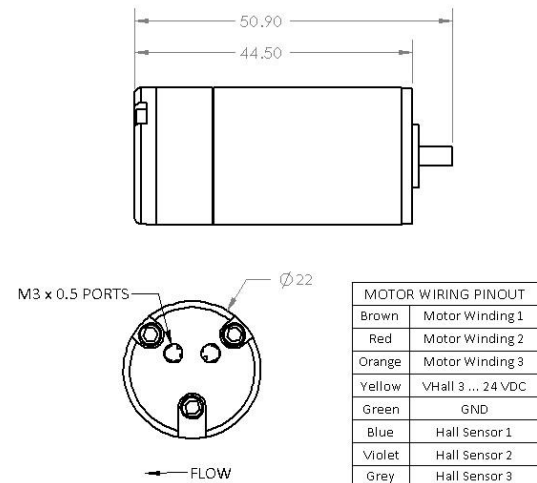

PERFORMANCE CHARTS

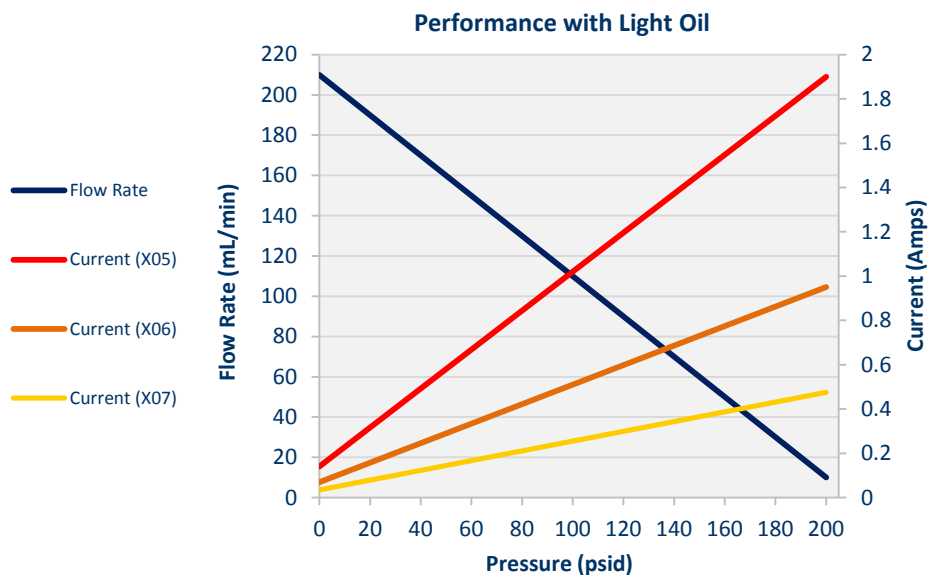

COMMON ACCESSORIES (Contact Flight Works to Purchase)

FLOW SYSTEM ITEMS

- Filters: 10, 25, 50 Microns
- Fittings: Tee/Elbow/Y/Adapters
- Valves: Ball/Check/Needle

CONTROL COMPONENTS

- Brushless Speed Controllers
- Pressure Gauges/Regulators

TUBING

- Polyurethane Tubing: 3, 4, 6mm
- Tygon Tubing: Medium, Large
- Stainless Steel Tubing: 1/16", 1/8"

PDS012-N/C